

Model No. PN28058-TH
PN28058-MY
PN28058-ID
PN28058-SG

- Thank you for purchasing our product.
- This document provides important information about safe and proper operations of this Switching Hub.
- Please read the **"Important Safety Instructions"** on pages from 3 to 5.
- Any problems or damage resulting from disassembly of this Switching Hub by customers are not covered by the warranty.

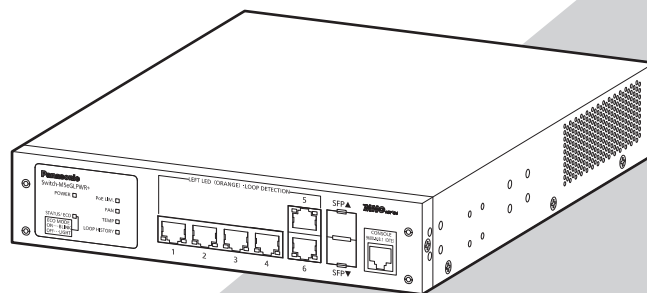

Contents

Important Safety Instructions	3
Basic Instructions for the Use of This Product	6
1 Product Outline	7
1.1 Features	7
1.2 Specifications	8
1.3 Accessories	9
1.4 Basic operation	9
2 Part Names and Functions	10
2.1 LED display change	13
2.2 PoE power supply function	14
3 Installation and Configuration	15
3.1 Mounting to rack	15
3.2 Configuration of IP address (Basic)	16
Troubleshooting	18

Important Safety Instructions

This chapter contains important safety instructions for preventing bodily injury and/or property damage. You are required to follow them.

- Severity of bodily injury and/or property damage, which could result from incorrect use of the Switching Hub, are explained below.



This symbol indicates a potential hazard that could result in serious injury or death.



This symbol indicates safety instructions. Deviation from these instructions could lead to bodily injury and/or property damage.

- The following symbols are used to classify and describe the type of instructions to be observed.



This symbol is used to alert users to what they must not do.



This symbol is used to alert users to what they must do.

WARNING



- Do not use power supply other than AC 100 - 240 V.
Deviation could lead to fire, electric shock, and/or equipment failure.
- Do not handle the power cord with wet hand.
Deviation could lead to electric shock, and/or equipment failure.
- Do not handle this Switching Hub and connection cables during a thunderstorm.
Deviation could lead to electric shock.
- Do not disassemble and/or modify this Switching Hub.
Deviation could lead to fire, electric shock, and/or equipment failure.
- Do not damage the power cord. Do not bend too tightly, stretch, twist, bundle with other cord, pinch, put under a heavy object and/or heat it.
Damaged power cord could lead to fire, short, and/or electric shock.
- Do not unplug nor plug in the power plug with wet hands.
Deviation could lead to electrical shock, and/or equipment failure.
- Do not insert nor drop any foreign objects such as metal or readily combustible things into the inside through the openings.
Deviation could lead to fire, electrical shock, and/or equipment failure.
- Do not store or use the Switching Hub in places where it might get splashed with liquids such as water, in places with a lot of humidity, in places with conductive dust, or in places where there are corrosive and combustible gases.
Deviation could lead to fire, electrical shock, and/or equipment failure.
- Do not store or use the Switching Hub in places where it will be exposed to direct sunlight or high temperatures.
The temperature inside will rise, which may cause fire.
- Do not store or use the Switching Hub in places where there are lots of vibrations and impacts, or in unstable areas.
It might fall, which may cause injuries and/or equipment failure.

WARNING



- **Do not put the Switching Hub into fire.**
Deviation could lead to explosion and/or fire.
- **Do not insert nor drop any foreign objects such as metal or readily combustible things into the inside through the openings, twisted pair ports, console ports, or SFP extension slots.**
Deviation could lead to fire, electrical shock, and/or equipment failure.

CAUTION



- **Handle the Switching Hub carefully so that fingers or hands may not be damaged by twisted pair port, SFP extension slot, console port, or power cord hook block.**
- **Do not connect any other devices except for 10BASE-T/100BASE-TX/1000BASE-T devices to the twisted pair ports.**
Deviation could lead to equipment failure.
- **Do not insert any other modules except for the our optional SFP module (PN54021K/PN54023K) to the SFP extension slots.**
- **Unplug the power plug when there is a malfunction.**
Deviation could lead to fire if the power is allowed to be supplied for extended periods of time.
- **Be sure to connect the ground cable.**
Otherwise this might cause electrical shocks, misoperations and malfunctions. Connect the Switching Hub via the supplied power cord to the outlet which is connected to the ground.
If the outlet is not connected to a ground, connect the ground cable to the ground terminal screw.
- **Use the bundled power cord (AC 100 – 240 V specifications).**
Deviation could lead to electric shock, malfunction, and/or equipment failure.
- **Unplug the power cord in case of equipment failure.**
Deviation, such as keeping connected for a long time, could lead to fire.
- **Connect this Switching Hub to ground.**
Deviation could lead to electric shock, malfunction, and/or equipment failure.
- **Connect the power cord firmly to the power port.**
Deviation could lead to electric fire, shock, and/or malfunction.
- **Unplug the power cord if the STATUS LED blinks in orange (system fault).**
Deviation, such as keeping connected for a long time, could lead to fire.

CAUTION



- **This Switching Hub is to be periodically serviced in order to maintain its performance.**
Please choose a product administrator, and have them be sure to implement periodic maintenance. When doing maintenance, check the inspection chart that is posted on our website which has the requisite items listed on it.
- **When using this Switching Hub to design systems, use it after applying appropriate measures such as setting up redundant configurations.**
Communications failures might be generated due to causes such as malfunctions or misoperations while the Switching Hub is being used.
- **When using this Switching Hub for applications which require extremely high reliability, be careful to expend all possible means to ensure safety and reliability.**
This Switching Hub was not designed nor manufactured with the intention that it be used for applications (in use with railways, aviation, and medical care, etc. whereas the influence rate due to communications failures is extremely high in regard to systems that directly affect systems and human lives) which require extremely high reliability.
- **It is strongly recommended that a lightning arrester (SPD) be installed on the twisted pair port side and the power supply side of this Switching Hub.**
Malfunctions might be caused due to overcurrent and overvoltage due to the effects of lightning strikes.
- **It is recommended that this Switching Hub be replaced about five years after it has been installed.**
This may vary depending upon conditions such as utilisation rates and usage environments, but performance might decrease due to the age-related degradation, etc. of components.
- **Be careful in regards to environmental restrictions whereby the Switching Hub can be used.**
Please isolate the business power lines and communications lines. Isolate distribution lines and other distribution lines, and low current power lines, optical fiber cables, metallic water conduits, and gas conduits, etc. Noise may be generated in the communications lines which might cause communications glitches.

Important Requests on Protection from Lightning Strike

- If you connect a network camera, a wireless access point, or other devices that can be affected by a lightning strike (in particular, devices installed outdoors) to the twisted pair port of this Switching Hub, a lightning surge current/voltage may be conducted to this Switching Hub through the twisted pair cable, leading to malfunction. If you connect such a device, it is strongly recommended that you install a surge protective device (SPD) on the twisted pair port side of this Switching Hub.
- A lightning surge current/voltage may be conducted to this Switching Hub through the power supply or ground wire connected to the power port, leading to malfunction. If a lightning surge current/voltage may flow in through the power supply or ground wire, it is recommended that you install a surge protective device (SPD) on the power port side of this Switching Hub.

Basic Instructions for the Use of This Product

- For inspection and/or repair, consult the retailer.
- Use commercial power supply from a wall socket, which is close and easily accessible to this Switching Hub.
- Unplug the power cord when installing or moving this Switching Hub.
- Unplug the power cord when cleaning this Switching Hub.
- Use this Switching Hub within the specifications. Deviation could lead to malfunction.
- Do not touch the metal terminal of the RJ45 connector, the modular plug of connected twisted pair cable. Do not place charged objects in the proximity of them. Static electricity could lead to equipment failure.
- Do not put the modular plug of the connected twisted pair cable on objects that can carry static charge, such as carpet. Do not place it in the proximity. Static electricity could lead to equipment failure.
- Do not put a strong shock, including dropping, to this Switching Hub. Deviation could lead to equipment failure.
- Before connecting a console cable to the console port, discharge static electricity, for example by touching metal appliance (do not discharge by touching this Switching Hub).
- Do not store and/or use this Switching Hub in the environment with the characteristics listed below.

(Store and/or use this Switching Hub in the environment in accordance with the specification.)

- High humidity. Possible spilled liquid (water).
 - Dusty. Possible static charge (such as carpet).
 - Under direct sunlight.
 - Possible condensation. High/low temperature exceeding the specifications environment.
 - Strong vibration and/or strong shock.
- Please use this Switching Hub in place where ambient temperature is from 0 to 50°C. Failure to satisfy the conditions above may result in a fire, electric shock, equipment failure, and/or malfunction. Such events are not covered by the warranty. Do not block the ventilator of the Switching Hub. Blocked ventilator induces the heat accumulation inside, causing equipment failure and/or malfunction. If used at a temperature out of the operating temperature range, the protection equipment becomes activated and PoE power supply stops.
 - When using two Switching Hubs, do not stack them. When you place them side by side, allow for a space of 20 mm or more between them. This space is not necessary if you use supplied connection brackets.
 - When stacking Switching Hubs, leave a minimum of 20 mm space between them.
 - Operation is not guaranteed if a module other than the optional SFP extension modules (PN54021K/PN54023K) is inserted into the SFP extension slot. For the latest information about compatible SFP extension modules, check our website.

1. Please note that Panasonic shall not bear any liability whatsoever for any damages (this shall include lost earnings, lost opportunities, etc. but this is not restricted to these things) which were generated in relation to damages caused by operations and usage, or the inability to use this Switching Hub, whereby the customer does not follow this Installation Guide.
2. The contents described in this document may be changed without prior notice.
3. For any question, please contact the retailer where you purchased the product.

1 Product Outline

Switch-M5eGLPWR+ is an Ethernet Switching Hub with management function having 4 ports of 10/100/1000BASE-T and two pairs of 10/100/1000BASE-T ports and SFP extension slot, one of which is selectable.

Ports 1 to 4 support IEEE802.3at PoE power supply function.

1.1 Features

- Has wire-speed Layer 2 switching function.
- Ports 1 to 4 are 10/100/1000BASE-T ports corresponding to auto negotiation. Also their speed and communication mode can be switched by configuration. Ports 5 and 6 can be used as a 10/100/1000BASE-T port corresponding to auto negotiation or an SFP extension slot exclusively.
- Ports 1 to 4 can supply power conforming with IEEE802.3at. Supplying power up to 30 W per port, and up to 62 W in total is possible.
- All twisted pair ports support straight/cross cable auto sensing function. Simply connect devices with straight cables, whether it is a terminal or a network device. (This function does not work if the port communication configuration is set at Fixed or Link Aggregation. Ports 1 to 4 are set at MDI-X. (default))
- Telnet allows remote configuration changes and verifications of the Switching Hub. Remotely configure the PoE settings for each port (Ports 1 to 4).
- Equipped with energy efficient Ethernet (EEE) conforming to IEEE802.3az (LPI). When there is no data transmission at link up, the energy-saving state automatically starts so that power consumption can be reduced on each port.
- Embedded power saving mode detects the connection status automatically and saves power consumption to minimum.
- VLAN function allows free grouping of up to 256 VLANs.
- The IEEE802.1w Rapid Spanning Tree Protocol is supported, allowing to build a system with redundancy.
- The IEEE802.1p compatible QoS function is supported.
- The IEEE802.1X compatible user authentication function (EAP-MD5/TLS/PEAP) is supported.
- Has an Internet Mansion function, which ensures security between each door.
- Due to the loop detection/shutoff function, a port where loop has occurred can be automatically shut off to prevent loop failures. When a port is shut off and recovered automatically, SNMP trap can be sent to notify the incident to the administrator. Moreover, the port with a loop can be identified by loop notification on the LEDs on the main unit and referring the history of loop on the setting screen.
- The PoE scheduler function enables scheduling of PoE power supply control.

1 Product Outline

1.2 Specifications

Interface	Twisted pair port 1–6: RJ45 connector Transmitting and receiving network system IEEE 802.3 10BASE-T IEEE 802.3u 100BASE-TX IEEE 802.3ab 1000BASE-T SFP extension slot 5,6 * Select either of RJ45 or SFP for use IEEE 802.3z Console port: RJ45 connector Transmitting and receiving network system RS-232C (ITU-TS V.24)
Switching mode	Store and Forward method: Forwarding rate 10BASE-T: Max. 14,880 pps/port 100BASE-TX: Max. 148,800 pps/port 1000BASE-T: Max. 1,488,000 pps/port MAC Address table: Max. 8K entry/unit Buffer: 512KByte/unit
Link Aggregation	IEEE802.3ad Configurable up to 3 groups (Max. 6 ports per group)
VLAN	IEEE802.1Q tagging VLAN protocol compatible (Max. 256 groups including the default VLAN) Port based VLAN, Internet Mansion function
QoS	IEEE802.1p compatible, Supports 4 priority queues
Management method	SNMP v1/v2c, Telnet, Console, SSH v2, WEB control screen
Power supply function	Ports 1 to 4 support the IEEE802.3at compatible power supply function. Maximum power supply: 30 W per port, 62 W in total
Power supply method	Alternative A (Using signal line, 1, 2, 3, 6)
Others	IEEE802.1D spanning tree IEEE802.1w rapid spanning tree IEEE802.1X authentication function supported (port-base authentication) Port monitoring, ring protocol, IGMP snooping, loop detection/shutoff function, storm control, DSCP mapping function, login RADIUS function, DHCP client function, PoE scheduler function
Power supply	AC 100-240 V, 50/60 Hz, 3.0 A
Power consumption	Normally, Max. 83.8 W (12.7 W when not supplying power), Min. 9.3 W
Operating environment	Temperature: 0–50°C, Humidity: 20–80% RH (no condensation) Caution: Failure to meet the above conditions may result in fire, electric shock, breakdown, and/or malfunction. Please take notice because such cases are out of guarantee.
Storage environment	Temperature: -20–70°C, Humidity: 10–90% RH (no condensation)
External dimensions	44 mm (Height) × 210 mm (Width) × 260 mm (Depth) (Excluding protruding sections)
Mass (Weight)	1,900 g

1.3 Accessories

Please be sure to confirm the content.

Please contact our distributor if any of the contents are insufficient.

Quantity

- Installation Guide (this document) 1 (*)
- CD-ROM (PDF version of Operating Instructions) 1
- Rubber foot 4
- Mounting bracket (for 19-inch rack) 2
- Connecting bracket 2
- Screw (for 19 inch rack) 4
- Screw (for fixing the main unit and the 19 inch rack mount bracket) 8
- Screw (for Connecting bracket) 8
- Power cord 1

* Just the PN28058-TH has 1 Installation Guide in Thai (a total of 2 guides).

[Power Cord]

The following power cords are supplied as per the intended nation of delivery.

Product Number	Locale	Power Cord Rating	FUSE Rated Current	Plug Type
PN28058-TH	Thailand	250 VAC 6 A	-	TIS166-2549
PN28058-MY	Malaysia	250 VAC 10 A	13 A	BS1363
PN28058-ID	Indonesia	250 VAC 10 A	-	CEE7/7
PN28058-SG	Singapore	250 VAC 5 A	5 A	BS1363

[Optional accessories]

- PN54021K-XX 1000BASE-SX SFP Module
- PN54023K-XX 1000BASE-LX SFP Module

The XXs are identical to the intended nation of delivery codes.

1.4 Basic operation

This Product does not have a power ON/OFF switch. Connect the supplied power cord to this Switching Hub and connect the other end into an electric outlet.

This Switching Hub operates at AC 100 - 240 V (50/60 Hz).

When power is supplied, all the LEDs are turned ON.

Then, POWER LED (Power) lights in green, STATUS/ECO LED (Status/ECO mode) lights in orange, and self-diagnosis of hardware is executed.

On completion of self-diagnosis, POWER LED (Power), STATUS/ECO LED (Status/ECO mode) and TEMP LED (Temperature sensor) light in green, and the Switching Hub starts operation as a Switching Hub.

As this Switching Hub succeeds in communicating with a terminal connected to each port, LED of the port lights up.

When the terminal is not operating normally, for example when power is not supplied to the terminal, LED is not lighted.

For configuration and management method, please see the PDF version Operating Instructions in CD-ROM.

2 Part Names and Functions

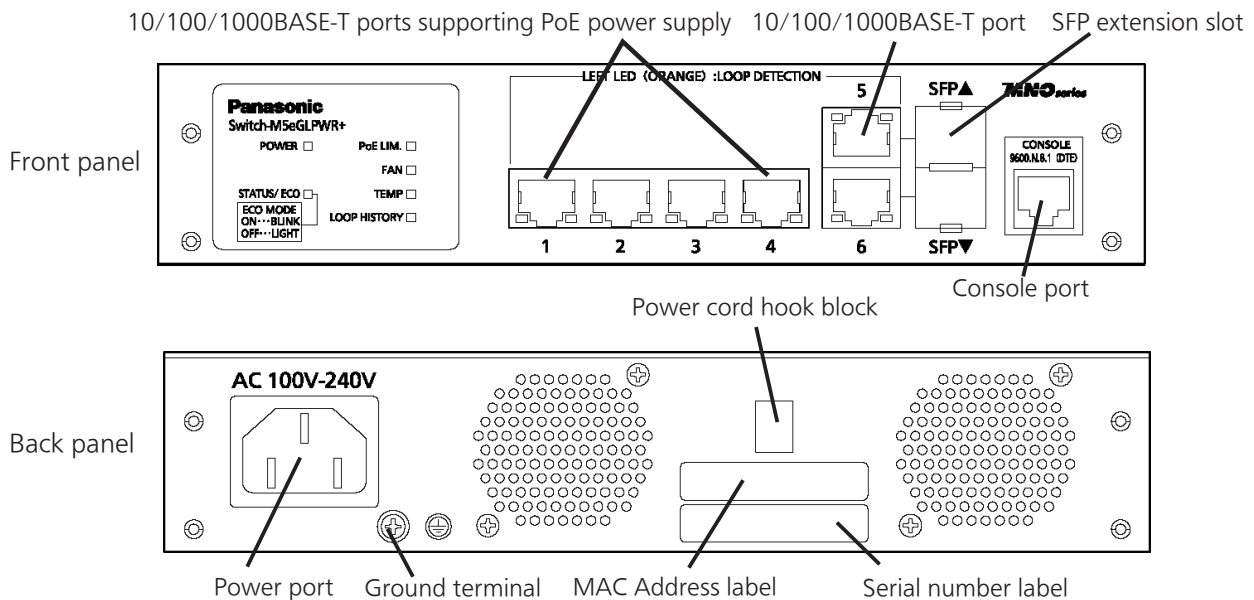

- **Power port**

Connect the supplied power cord to this port and connect the other end into an electric outlet.

- **Power cord hook block**

If the supplied power cord is hanged to this block, the cord becomes hard to pull out from the power port.

- **Ground terminal**

Only qualified personnel should install minimum 18AWG green-and-yellow stranded copper wire to Ground terminal screw.

- **10/100/1000BASE-T port (ports 1–4) supporting PoE power supply**

The port can supply PoE power conforming with IEEE802.3at. Connect a Powered Device conforming with IEEE802.3at. Devices such as 10/100/1000BASE-T terminal, hub, repeater, bridge, and Switching Hub can be connected to this port. Install the device so that the length of twisted pair cable (CAT5e or above) becomes 100 m or less.

- **10/100/1000BASE-T port (ports 5,6)**

Devices such as 10/100/1000BASE-T terminal, hub, repeater, bridge, and Switching Hub can be connected to this port.

Install the device so that the length of twisted pair cable (CAT5e or above) becomes 100 m or less.

- **SFP extension slot (ports 5,6)**

Install SFP module. (It becomes exclusive usage with twisted pair port.)

When SFP extension slot is linked, the port is automatically switched to SFP extension mode.

SFP port supports only the full duplex communication.

- **Console port**

Connect a VT100 compatible terminal, etc. with this port to configure or manage this Switching Hub.

Transmission mode : RS-232C

Emulation mode : VT100

Transmission speed : 9,600 bps

Data length : 8 bits

Stop bit : 1 bit

Parity control : None

Flow control : None

Transmission connector : RJ45

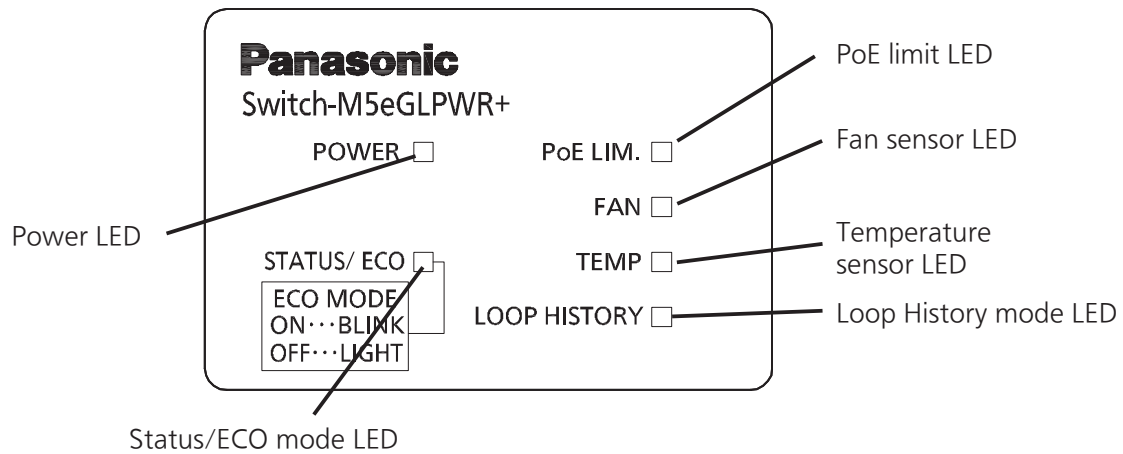

- **POWER LED (Power)**

Green Light : Power is ON.
Off : Power is OFF.

- **STATUS/ECO LED (Status/ECO mode)**

Green Light : Operating in status mode.
Green Blink : Operating in ECO mode.
All Port LEDs (left) are turned off.
Orange Light : Starting
Orange Blink : Malfunction (Contact the seller.)

- **PoE LIM. LED (PoE limit)**

Off : Supplying power in the range from 0 to 47 W.
Green Light : Supplying power in the range from 47 to 62 W.
Orange Blink : A single port's power supply is exceeding the upper limit, or the total power supply of the Switching Hub is exceeding 62 W.

- **FAN LED (Fan sensor)**

Green Light : System is operating normally.
Orange Blink : Fan fault is occurring.

- **TEMP LED (Temperature sensor)**

Green Light : The system is normally operating.
Orange Blink : The temperature exceeded the set threshold of the internal temperature sensor.
Set threshold of the internal temperature sensor: 63°C (factory default)

- **LOOP HISTORY LED (Loop History mode)**

Green Light : Operating in Loop History mode.
Green Blink : Loop is occurring, or occurred within the last 3 days.

2 Part Names and Functions

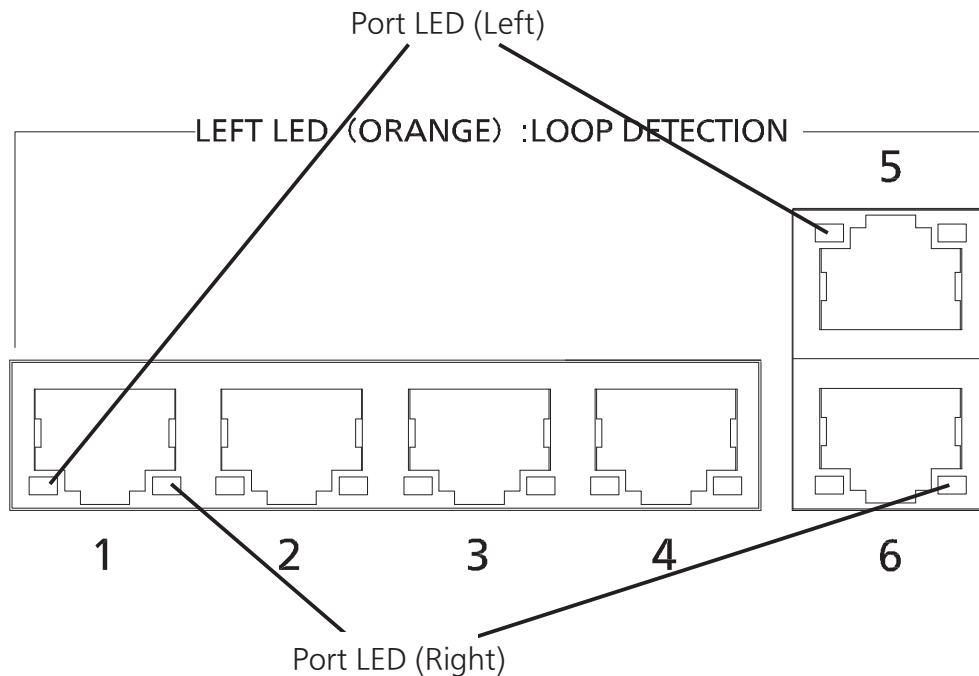

- **Port LED (Left)**

Green Light (when the LOOP HISTORY LED is off)

: Link is established at 10/100/1000 Mbps.

Green Light (when the LOOP HISTORY LED is Blink)

: Within three days after a loop has been eliminated

Green Blink

: Data is being sent/received at 10/100/1000 Mbps.

Orange Light

: Shut off by the loop detection/shutoff function

Off

: No terminal is connected or the ECO mode is set.

- **Port LED (Right)**

Green Light

: Power is supplied normally. (Ports 1 to 4 only)

Orange Blink

: Overload power supply (Ports 1 to 4 only) or overload in a single port

Off

: Power is not supplied or PoE receiving equipment is not connected.

2.1 LED display change

- **Two types of Base modes**

The mode at the start is called "Base mode."

There are two types of Base modes: Status mode (factory default setting) and ECO mode.

In the Status mode, you can check the terminal connection status by checking Port LED (left) lamps.

In the ECO mode, all Port LED lamps are off.

You can switch between the Status mode and ECO mode by command setting.

(For details, refer to the attached CD-ROM.)

- **About Loop detection**

Turns on the port LED with a orange light when a loop occurs in the corresponding port.

At this time, the relevant port automatically shuts down (default setting: 60 sec.) to prevent loop from occurring.

If the loop is still not removed, the port will shut down again. Remove the loop while the port is shut down.

During loop is occurring, or if loop has occurred within the latest 3 days, LOOP HISTORY LED blinks to notify this. It is possible to switch loop detection setting (OFF/ON) by using a console cable (for detail, see the attached CD-ROM). The default setting is ON.

If you wish to clear loop detection history, turn OFF once the power supply of the Switching Hub and turn it ON again.

Then, loop detection history is deleted.

The Switching Hub can hold up to 64 loop history logs.

2 Part Names and Functions

2.2 PoE power supply function

- **PoE power supply function operation overview**

Ports 1 to 4 support IEEE802.3at PoE. This function allows for power supply of up to 30 W through each port and 62W in total through the Switching Hub.

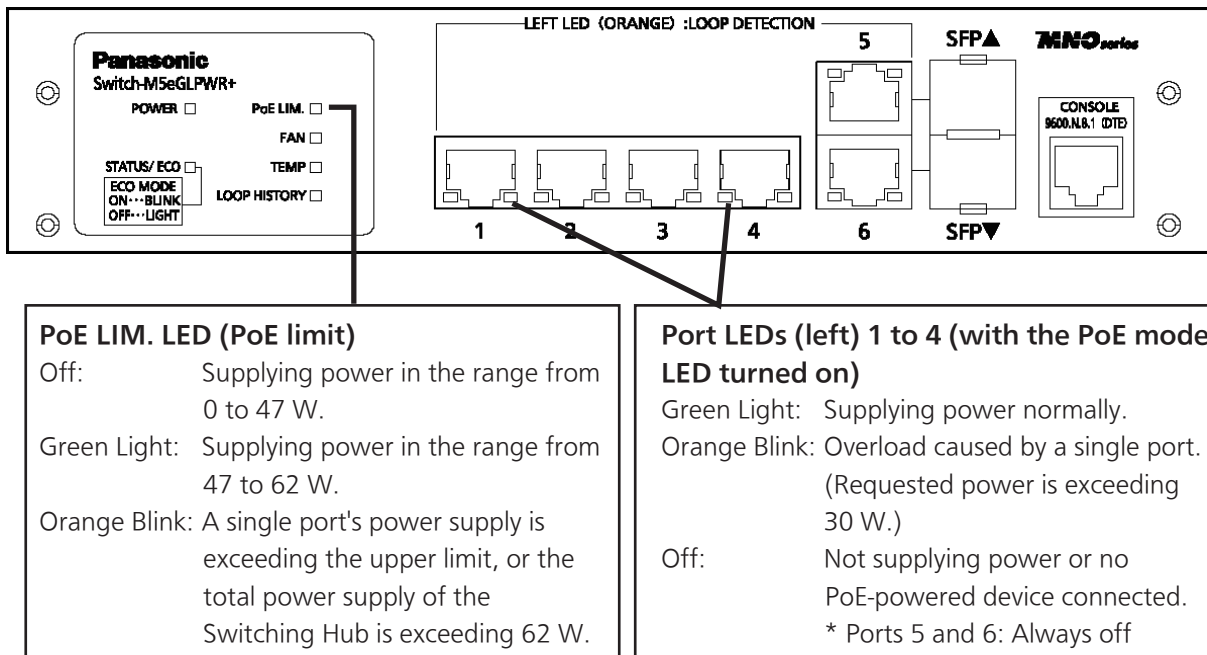

- **Power supply while the PoE LIM. LED is blinking orange (overload caused by the total power supplied by the Switching Hub)**

When the requested power supply of the Switching Hub exceeds 62 W, causing an overload, you can check a port that stopped supplying power by changing the mode LED display to that of PoE mode. Remove the cable from the port with its LED blinking orange to reduce the requested power supply of the Switching Hub to 62 W or below.

You can set/change the priority of the power supply from the console.
(By factory default, the same priority is given to all Ports 1 to 4.)

*** For configuration and management method, please see the PDF version Operating Instructions in CD-ROM.**

- **Power supply while the overload is caused by a single port**

When the requested power supply of a single port exceeds 30 W, causing an overload, the power supply is stopped. You can check a port that stopped supplying power by changing the mode LED display to that of PoE mode.

Remove the cable from the port with its LED blinking orange.

Caution: 1) Some PoE-powered devices may have a large difference in power consumption between their maximum power use condition and normal condition. Carefully configure them so that the upper limit of power supply will not be exceeded.

2) If you don't set a priority for power supply or if the same priority is given, note that the power supply priority is assigned to the ports in ascending order of the port numbers. (When the requested power supply exceeds 62W, power supply to a port with a higher port number will be stopped first.)

3 Installation and Configuration

3.1 Mounting to rack

Use the supplied two 19-inch rack mount brackets and supplied eight screws (for fixing the mount brackets to the Switching Hub) to fix the mount brackets to the four holes on each side of the Switching Hub. Then securely install the Switching Hub on the rack using the supplied four screws (for a 19-inch rack mount) or screws supplied with the rack. Up to two Switching Hubs can be connected. When connecting two Switching Hubs and installing them on a rack, use the supplied two 19-inch rack mount brackets and eight screws (for fixing the mount brackets to the Switching Hub) to fix the mount brackets to the four holes on a side of the Switching Hubs. Then use the supplied two connection brackets and eight screws (for fixing the connection brackets) to securely fix the connection brackets to the connection screw holes on the front and back panels, and then install the Switching Hubs on the rack.

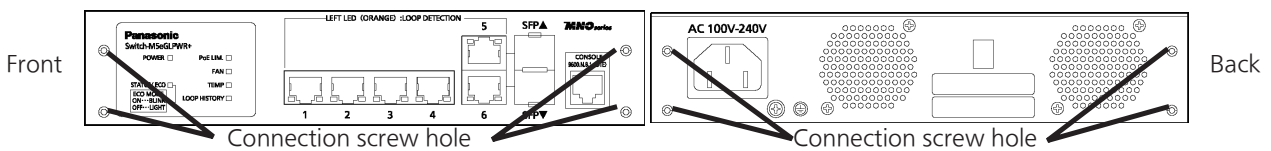
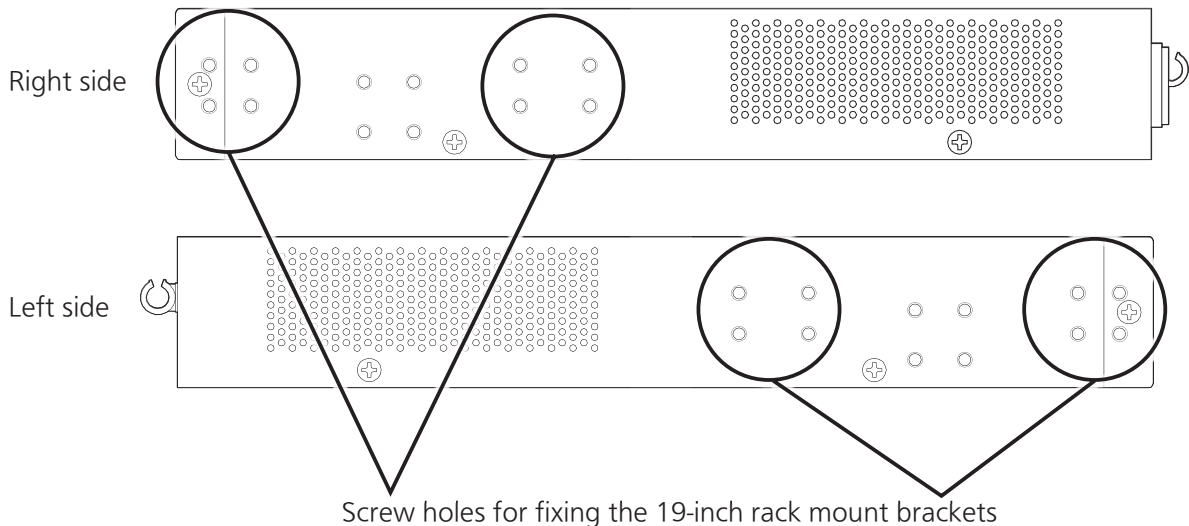

- Installation on a rack (one unit)

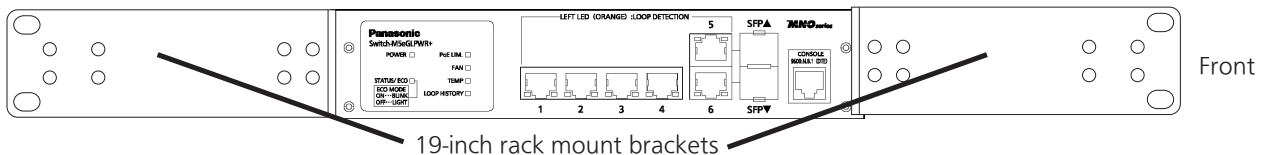

- Installation on a rack (two units connected)

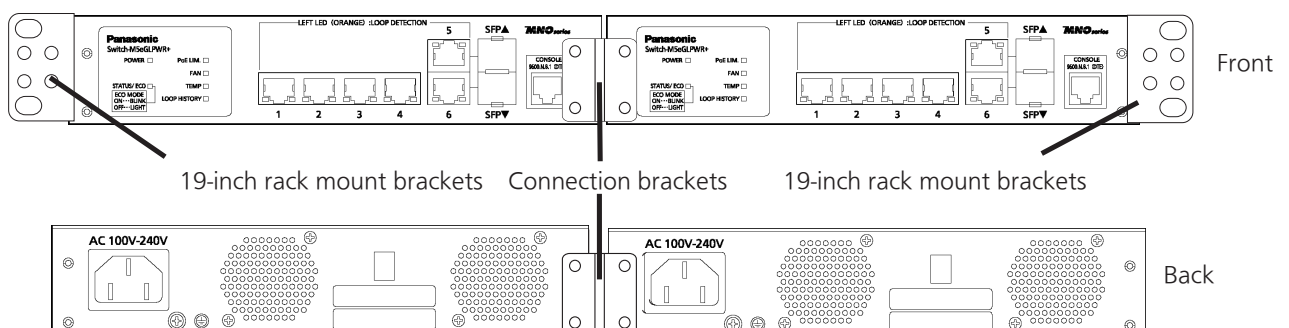

3 Installation and Configuration

3.2 Configuration of IP address (Basic)

- (1) Connect this Switching Hub and PC with a RJ45–DSub 9-pin console cable and start up the terminal emulator (Z EQUO assist Plus, etc.).
- (2) Pressing Enter key 3 times opens Login screen. Enter Login name and Password (the default is "manager" for both). **(Screen 1)**
- (3) Main Menu is displayed. **(Screen 2)**
Press "B" to select [B]asic Switch Configuration. The next hierarchical menu is displayed. **(Screen 3)**
- (4) Press "I" to select System [I]P Configuration. The screen to enter some addresses is displayed. **(Screen 4)**
- (5) Press "I" to set an IP Address, press "M" to set a Subnet Mask, or press "G" to set a Default Gateway. Then enter the specified address. **(Screen 4)**
- (6) After completing the settings, select [Q]uit to previous menu twice to return to Main Menu **(Screen 2)**. Here, select Save Configuration to [F]lash **(Screen 5)** and the command prompt changes to "Save current configuration?(Y/N)." Press "Y" to save the settings.
- (7) From terminals connected to network, confirm that the settings are reflected correctly by executing PING test for entered address.

3.2 Configuration of IP address (Basic)

```

=====
PN28058 Local Management System Version 8.0.0.0.0.0
MAC Address: 00-90-40-54-22-24
=====

Login Menu

Login: 

```

Screen 1

```

PN28058 Local Management System

Main Menu

[G]eneral Information
[B]asic Switch Configuration...
[A]dvanced Switch Configuration...
[S]tatistics
Switch [T]ools Configuration...
Save Configuration to [F]lash
Run [C]LI
[Q]uit

Command> 
Enter the character in square brackets to select option

```

Screen 2

```

PN28058 Local Management System
Main Menu -> Basic Switch Configuration Menu

System [A]dministration Configuration
System [I]P Configuration
S[N]MP Configuration
[P]ort Configuration Basic
Port Configuration [E]xtend
Port Configuration [P]ower Saving
[S]ystem Security Configuration
[F]orwarding Database
[T]ime Configuration
A[R]P Table
[L]LDP Configuration
[Q]uit to previous menu

Command> 
Enter the character in square brackets to select option

```

Screen 3

```

PN28058 Local Management System
Basic Switch Configuration -> System IP Configuration Menu

MAC Address: 00-90-40-54-22-24
IP Address: 192.168.0.1
Subnet Mask: 255.255.255.0
Default Gateway: 192.168.0.254
DHCP Mode: Disabled

----- <COMMAND> -----

Set [I]P Address
Set Subnet [M]ask
Set Default [G]ateway
Set IP P[a]rameter
Set [D]HCP Status
Set DHCP [R]enew
[Q]uit to previous menu

Command> 
Enter the character in square brackets to select option

```

Screen 4

```

PN28058 Local Management System
Main Menu -> Save Configuration to Flash

Save current configuration? (Y/N)> 
Y for Yes; N for No

```

Screen 5

* For the following, please see the PDF version Operating Instructions in CD-ROM.

- Detailed configuration and management methods using the CLI.
- Configuration and management method from ZEQUO assist Plus.

Troubleshooting

If you find any problem, please take the following steps to check.

◆ LED

The POWER LED (Power) is not lit.

- Check if the power cord is disconnected. Please confirm that the power cord is securely connected to the power port.
- Is the Switching Hub being used at a temperature between 0 and 50°C?
Use the Switching Hub in its operating temperature range.

Note: If used at a temperature out of the operating temperature range, the protection equipment becomes activated and PoE power supply stops.

The default operating temperature range is 0 to 50 °C.

The Port LED is not lit in Status mode.

- Is the cable correctly connected to the target port?
- Is the cable appropriate to use?
- Is the terminal connected to the relevant port conforming with 10BASE-T, 100BASE-TX, or 1000BASE-T standard?
- Auto-negotiation may have failed.

Check the port settings of this Switching Hub or the terminal settings.

The Port LED (Right) lights in orange.

- Loop is occurring. By removing the loop, orange LED will be turned off.

LOOP HISTORY LED Blinks in orange.

- This is to notify that there is a port in which a loop is occurring, or has been removed within 3 days.

◆ Communications are slow.

- Are the communication speed and mode settings correct?
If the proper communication mode signal cannot be obtained, apply half-duplex mode.
Please reconfirm autonegotiation setting.
- Is not the utilization ratio of the network to which this Switching Hub is connected too high?
Try separating this Switching Hub from the network.

◆ Communications fail.

- Is the link-up correct?
If embedded power saving mode is set to Full, change the setting to Half or Disabled.
- Is the Port LED (right) lit in orange?
If the Port LED (right) lit in orange, the port is shut down by the loop detection function. Eliminate the loop connection of the device connected to the port first, and then wait longer than the time required for automatic recovery from the shutdown by the loop detection function, or release the port shutdown from the setting screen.

◆ PoE power supply is impossible.

Power is not supplied to a Powered Device.

- If you use an STP cable, PoE power supply may not be possible depending on the installation environment. In such cases, use a UTP cable.
- Is a CAT5e or better straight cable (RJ45-8/8) used?
- Is the cable connected to the port 1–4 that supports PoE power supply?
- Ensure that either the port alone or the entire equipment is not overloaded.
- Is the Powered Device connected to the port compliant with the IEEE802.3at (30W) standard?

Port LED (Right) is blinking orange:

- Ensure that the total power supply demand from PoE-powered devices does not exceed 62 W .

When the power supply is suddenly shut off:

- It is likely that a PoE-powered device in use has a different power consumption in normal operation and standby states.

After turning on the PoE LED (power supply mode), confirm that a single port is not overloaded [the Port LED (left) is not blinking orange] and that the maximum limit of the total power supply is not exceeded (the PoE LIM. LED is not blinking orange).

*** For detailed configuration and management method, please see the PDF version Operating Instructions in CD-ROM.**