

## Installation Guide

## GA-AS10TPoE+

Model No. PN25108-TH  
PN25108-MY  
PN25108-ID  
PN25108-SG  
PN25108-NZ

- Thank you for purchasing our product.
- This document provides important information about safe and proper operations of this Ethernet Switch.
- Please read the **"Important Safety Instructions"** on pages from 3 to 5.
- Any problems or damages resulting from disassembly of this Ethernet Switch by customers are not covered by the warranty.
- The instruction manuals (Menu, Version, CLI Version Web Version), latest firmware and SDN application (ZEQUO assist Plus) can be downloaded from the following URL.  
<https://panasonic.co.jp/ew/pewnw/english/datadownload/index.html>

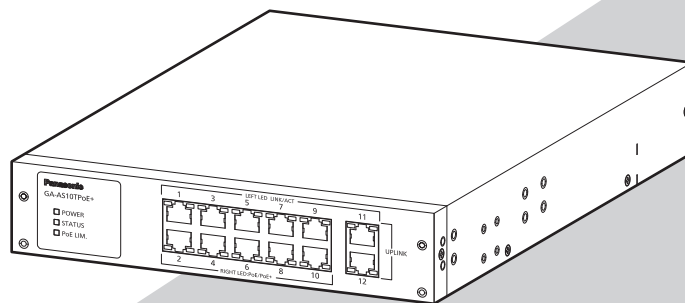

# Contents

Important Safety Instructions .....	3
Basic Instructions for the Use of This Product .....	6
1 Product Outline .....	7
1.1 Features .....	7
1.2 Specifications .....	8
1.3 Accessories .....	9
1.4 Basic operation .....	9
2 Part Names and Functions .....	10
3 Installation and Configuration .....	12
3.1 Grounding Cable Connection .....	12
3.2 Mounting to rack .....	13
3.3 Configuration of IP address (Basic) .....	14
Troubleshooting .....	16

# Important Safety Instructions

This chapter contains important safety instructions for preventing bodily injury and/or property damage. Please read carefully, and follow them at all times.

- Severity of bodily injury and/or property damage, which could result from incorrect use of the Ethernet Switch, are explained below.



This symbol indicates a potential hazard that could result in serious injury or death.



This symbol indicates safety instructions. Deviation from these instructions could lead to bodily injury and/or property damage.

- The following symbols are used to classify and describe the type of instructions to be observed.



This symbol is used to alert users what they must not do.



This symbol is used to alert users what they must do.

## **WARNING**



- Do not use power supply other than AC 100 - 240 V.  
Deviation could lead to fire, electric shock, and/or equipment failure.
- Do not handle the power cord with wet hand.  
Deviation could lead to electric shock, and/or equipment failure.
- Do not handle this Ethernet Switch and connection cables during a thunderstorm.  
Deviation could lead to electric shock.
- Do not disassemble and/or modify this Ethernet Switch.  
Deviation could lead to fire, electric shock, and/or equipment failure.
- Do not damage the power cord. Do not bend too tightly, stretch, twist, bundle with other cord, pinch, put under a heavy object and/or heat it.  
Damaged power cord could lead to fire, and/or electric shock.
- Do not insert or drop foreign objects, such as metal or combustible things into Ethernet Switches through the openings or twisted pair ports.  
Deviation could lead to fire, electric shock, and/or equipment failure.
- Do not connect equipments other than 10BASE-T/100BASE-TX/1000BASE-T to twisted pair port.  
When connecting to a 10BASE-T device, use a Cat5 or above cable.  
Deviation could lead to fire, electric shock, and/or equipment failure.
- Do not place this Ethernet Switch in harsh environment (such as near water, high humid, and/or high dust).  
Deviation could lead to fire, electric shock, and/or equipment failure.
- Do not place this Ethernet Switch under direct sunlight and/or high temperature.  
Deviation could lead to high internal temperature and fire.

## **WARNING**



- **Do not install this Ethernet Switch at the location with continuous vibration or strong shock, or at the unstable location.**  
Deviation could lead to falling, injury and/or equipment failure.
- **Do not put this Ethernet Switch into fire.**  
Deviation could lead to explosion and/or fire.

## **CAUTION**



- **Use the bundled power cord (AC 100 – 240 V specifications).**  
Deviation could lead to electric shock, malfunction, and/or equipment failure.
- **Unplug the power cord in case of equipment failure.**  
Deviation, such as keep connecting for a long time, could lead to fire.
- **Connect this Ethernet Switch to ground.**  
Otherwise this might cause electrical shocks, misoperations and malfunctions.  
Connect the Ethernet Switch via the supplied power cord to the outlet which is connected to the ground.  
If the outlet is not connected to a ground, connect the ground cable (AWG18: green/yellow) to the ground terminal screw.
- **Connect the power cord firmly to the power port.**  
Deviation could lead to electric fire, shock, and/or malfunction.
- **If the STATUS (Status) LED blinks in orange (system fault), unplug the power cord since this is a sign of malfunction.**  
Deviation, such as keep connecting for a long time, could lead to fire.
- **Handle the Ethernet Switch carefully to prevent fingers and hands from being damaged by twisted pair port or power cord hook block.**
- **Up to two Ethernet Switches can be connected. When connecting two Ethernet Switches, use connection brackets and screws (for fixing the connection brackets) supplied with 19-inch rack mount brackets (two coupled units) to securely fix the connection brackets to the connection screw holes on the front and back panels, and then install the Ethernet Switches.**  
If the Ethernet Switch is not fixed securely, injuries and/or malfunctions could be caused due to the Ethernet Switch falling, etc.
- **When connecting IEEE802.3at-enabled receiving equipment to the Ethernet Switch, use a CAT5e or above cable. Using cables other than those could lead them to cause heat to be generated, to catch on fire and/or cause malfunctions.**
- **Double pole / Neutral fusing**

# CAUTION



- **This Ethernet Switch is to be periodically serviced in order to maintain its performance.**  
Please assign a product administrator, and be sure to implement periodic maintenance. When doing maintenance, check the inspection chart that is posted on our website which has the requisite items listed on it.
- **When using this Ethernet Switch to design systems, use it after applying appropriate measures such as setting up redundant configurations.**  
Communication failures might be generated due to causes such as malfunctions or misoperations while the Ethernet Switch is being used.
- **When using this Ethernet Switch for applications which require extremely high reliability, be careful to expend all possible means to ensure safety and reliability.**  
This Ethernet Switch is not designed nor manufactured with the intention that it be used for applications (in use with railways, aviation, and medical care, etc. whereas the influence rate due to communication failures is extremely high in regard to systems that directly affect systems and human lives) which require extremely high reliability.
- **Be aware of glitches which are caused in the usage environments such as age-related degradation, etc.**  
This may vary depending upon conditions such as utilisation rates and usage environments, but performance might decrease due to the age-related degradation, etc. of components. It is recommended that this Ethernet Switch be replaced about five years after it has been installed.
- **Be careful in regards to environmental restrictions whereby the Ethernet Switch can be used.**  
Please isolate the business power lines and communication lines. Isolate distribution lines and other distribution lines, and low current power lines, optical fiber cables, metallic water conduits, and gas conduits, etc. Noise may be generated in the communication lines which might cause communication glitches.

## Important Requests on Protection from Lightning Strike

- If you connect a network camera, a wireless access point, or other devices that can be affected by a lightning strike (in particular, devices installed outdoors) to the twisted pair port of this Ethernet Switch, a lightning surge current/voltage may be conducted to this Ethernet Switch through the twisted pair cable, leading to malfunction. If you connect such device, it is strongly recommended that you install a surge protective device (SPD) on the twisted pair port side of this Ethernet Switch.
- A lightning surge current/voltage may be conducted to this Ethernet Switch through the power supply or ground wire connected to the power port, leading to malfunction. If a lightning surge current/voltage may flow in through the power supply or ground wire, it is recommended that you install a surge protective device (SPD) on the power port side of this Ethernet Switch.

## Basic Instructions for the Use of This Product

- For inspection and/or repair, consult the retailer.
- Use commercial power supply from a wall socket, which is close and easily accessible to this Ethernet Switch.
- Unplug the power cord when installing or moving this Ethernet Switch.
- Unplug the power cord when cleaning this Ethernet Switch.
- Use this Ethernet Switch within the specifications. Deviation could lead to malfunction.
- Do not touch the twisted pair cable modular metal terminals which are connected to RJ45 connectors (twisted pair ports) or the connectors, nor place them near electrically-charged objects. Static electricity could lead to equipment failure.
- Do not put the modular plug of the connected twisted pair cable on objects that can carry static charge, such as carpet. Do not place it in the proximity. Static electricity could lead to equipment failure.
- Do not put a strong shock, including dropping, to this Ethernet Switch. Deviation could lead to equipment failure.
- Do not store and/or use this Ethernet Switch in the environment with the characteristics listed below.  
(Store and/or use this Ethernet Switch in the environment in accordance with the specification.)
  - High humidity. Possible spilled liquid (water).
  - Dusty. Possible static charge (such as carpet).
  - Under direct sunlight.
  - Possible condensation. High/low temperature exceeding the specifications environment.
  - Strong vibration and/or strong shock.
- Please use this Ethernet Switch in place where ambient temperature is from 0 to 50°C. Failure to satisfy the conditions above may result in a fire, electric shock, equipment failure, and/or malfunction. Such events are not covered by the warranty.  
Do not block the ventilator of the Ethernet Switch.  
Blocked ventilator induces the heat accumulation inside, causing equipment failure and/or malfunction.
- If used at a temperature out of the operating temperature range, the protection equipment becomes activated and the power supply stops.
- When using two Ethernet Switches, do not stack them. When you place them side by side, allow for a space of 20 mm or more between them.

1. Please note that Panasonic shall not bear any liability whatsoever for any damages (this shall include lost earnings, lost opportunities, etc. but this is not restricted to these things) which were generated in relation to damages caused by operations and usage, or the inability to use this Ethernet Switch, whereby the customer does not follow this Installation Guide.
2. The contents described in this document may be changed without prior notice. For the latest version, please refer to the Panasonic website.
3. For any question, please contact the retailer where you purchased the product.

# 1 Product Outline

GA-AS10TPoE+ has 12 ports which are 10BASE-T/100BASE-TX/1000BASE-T compatible ports.

Ports 1 to 10 (twisted pair ports) support IEEE802.3at PoE power supply functions.

## 1.1 Features

- Ports 1 to 12 (twisted pair ports) are 10BASE-T/100BASE-TX/1000BASE-T corresponding to auto-negotiation.
- The twisted pair ports 1 to 10 can supply power conforming with IEEE802.3at. They can supply a maximum of 30 W of power per port, and the device total can supply a maximum of 70 W of power.
- All of the twisted pair ports are equipped with straight/cross cable automatic detection functions. Straight cables can be used to make interconnections without distinctions between the terminals and network devices having to be made. (The factory default is for ports 1 to 10 to have MDI-X be fixed.)
- Equipped with IEEE802.3az (LPI) compatible Energy Efficient Ethernet functions (hereinafter EEE), and if data is transmitted when linked up, the energy efficient state will be moved to, whereas each port can suppress power consumption.
- Automatically detects the connection states via the equipped energy efficiency mode, and suppresses power consumption to required levels.
- VLAN function allows free grouping of up to 256 VLANs.
- The IEEE802.1p compatible QoS function is supported.
- Has an Internet Mansion function, which ensures security between each door.
- As a factory default, IP address in this Ethernet Switch is not assigned to the device. The address can be changed by connecting this Ethernet Switch to your PC using twisted pair cable, if your PC has ZEQUO assist plus installed on it (ZEQUO assist plus is downloadable from Panasonic's website)

# 1 Product Outline

## 1.2 Specifications

<b>Interface</b>	Twisted pair port 1–12: RJ45 connector Transmitting and receiving network system IEEE 802.3 10BASE-T IEEE 802.3u 100BASE-TX IEEE802.3ab 1000BASE-T Energy Efficient Ethernet function IEEE 802.3az (LP1)
<b>Switching mode</b>	Store and Forward method: Forwarding rate 10BASE-T: Max. 14,880 pps/port 100BASE-TX: Max. 148,800 pps/port 1000BASE-T: Max. 1,488,000 pps/port MAC Address table: Max. 8K entry/unit Buffer: 512MByte
<b>Link Aggregation</b>	IEEE802.3ad Configurable up to 6 groups (Max. 8 ports per group)
<b>VLAN</b>	IEEE802.1Q tagging VLAN protocol compatible (Max. 256 groups including the default VLAN) Port based VLAN, Internet Mansion function
<b>QoS</b>	IEEE802.1p compatible, Supports 4 priority queues
<b>Management method</b>	WEB control screen, ZEQUO assist Plus
<b>Power supply function</b>	Ports 1 to 10 support the IEEE802.3at compatible power supply function. Maximum power supply: 30 W per port, 70 W in total
<b>Power supply method</b>	Alternative A(Using idle line 1,2,3,6)
<b>Others</b>	Port Monitoring, Storm control
<b>Power supply</b>	AC 100–240V, 50/60 Hz, 1.7 A
<b>Power consumption</b>	Normally, Max. 89.6 W (12.1 W when not supplying power), Min. 7.5 W
<b>Operating environment</b>	Temperature: 0–50°C, Humidity: 20–80% RH (no condensation) Caution: Failure to meet the above conditions may result in fire, electric shock, breakdown, and/or malfunction. Please take notice because such cases are not covered by the guarantee.
<b>Storage environment</b>	Temperature: -20–70°C, Humidity: 10–90% RH (no condensation)
<b>Fan</b>	Not installed
<b>External dimensions</b>	44 mm (Height) × 210 mm (Width) × 280 mm (Depth) (Excluding protruding sections)
<b>Mass (Weight)</b>	2,200 g

## 1.3 Accessories

Please be sure to confirm the content.

Please contact our distributor if any of the contents are insufficient.

	Quantity
● Installation Guide (this document) .....	1 (*)
● Rack mount bracket (for 19-inch rack) .....	2 (**)
● Connection bracket (for connection two Ethernet Switches) .....	2 (**)
● Screw (for 19-inch rack) .....	4 (**)
● Screw (for fixing the mount brackets to the Ethernet Switch) .....	8 (**)
● Screw (for fixing the connection bracket) .....	8 (**)
● Rubber foot .....	4
● Power cord .....	1

\* Just the PN25108-TH has 1 Installation Guide in Thai (a total of 2 guides).

\*\*Includes PN25108-NZ only.

[Power Cord]

The following power cords are supplied as per the intended nation of delivery.

Product Number	Locale	Power Cord Rating	FUSE Rated Current	Plug Type
PN25108-TH	Thailand	250 VAC 6 A	-	TIS166-2549
PN25108-MY	Malaysia	250 VAC 10 A	13 A	BS1363
PN25108-ID	Indonesia	250 VAC 10 A	-	CEE7/7
PN25108-SG	Singapore	250 VAC 5 A	5 A	BS1363
PN25108-NZ	Australia New Zealand	250 VAC 10 A	-	AS/NZS 3112

## 1.4 Basic operation

This Product does not have a power ON/OFF switch. Connect the supplied power cord to this Ethernet Switch and connect the other end into an electric outlet.

This Ethernet Switch operates at AC 100 - 240 V (50/60 Hz).

When power is supplied, all the LEDs are turned ON.

Subsequently, the POWER (power) LED lights up green, and the STATUS (status) LED lights up orange and the hardware runs a self-diagnostic.

When it is finished, both the the POWER (power) LED and STATUS (status) LED light up green, and it operates as an Ethernet Switch.

As this Ethernet Switch succeeds in communicating with a terminal connected to each port, LED of the port lights up.

When the terminal is not operating normally, for example when power is not supplied to the terminal, LED is not lighted.

**\* For configuration and management method, please see the PDF version Operating Instructions on Panasonic's website.**

## 2 Part Names and Functions

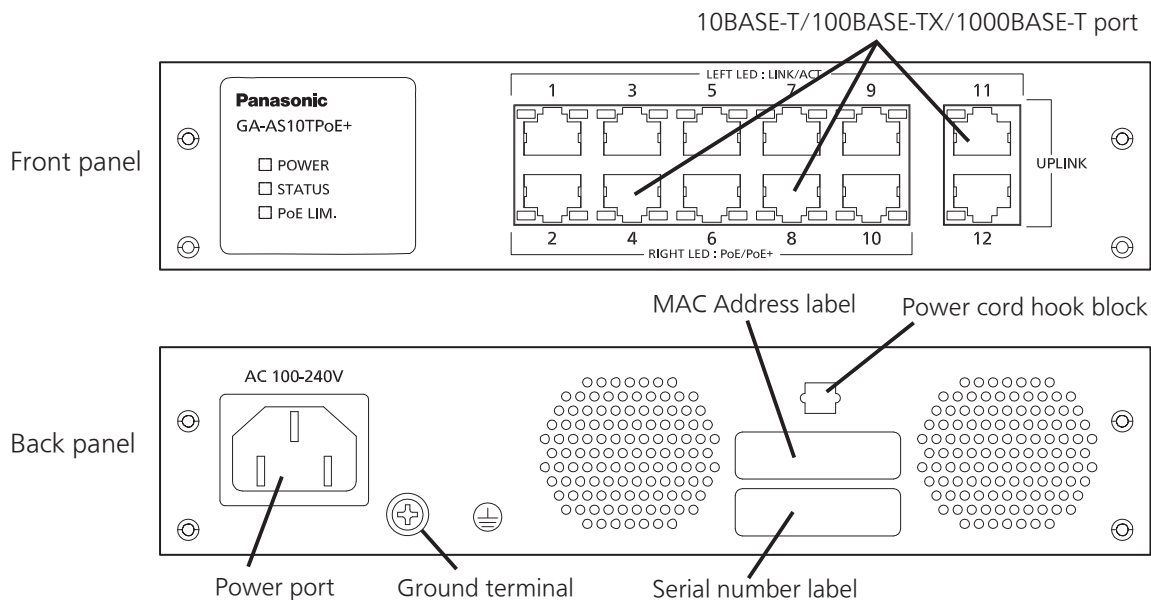

- **Power port**

Connect the supplied power cord to this port and connect the other end into an electric outlet.

- **Power cord hook block**

If the supplied power cord is hanged to this block, the cord becomes hard to pull out from the power port.

- **Ground terminal**

Connect the ground cable (AWG18: green/yellow) to the ground terminal screw.

- **10BASE-T/100BASE-TX/1000BASE-T port (ports 1–12)**

Connect 10BASE-T/100BASE-TX/1000BASE-T terminals, hubs, repeaters, bridges, and Ethernet Switches.

Install the device so that the length of the twisted pair cables (CAT5e or above) will be 100 m or less.

- **PoE power supply ports (ports 1–10)**

The port can supply PoE power conforming with IEEE802.3at. Connect a Powered Device conforming with IEEE802.3at. Devices such as 10/100/1000BASE-T terminal, hub, repeater, bridge, and Ethernet Switch can be connected to this port. Install the device so that the length of twisted pair cable (Cat5e or above) becomes 100 m or less.

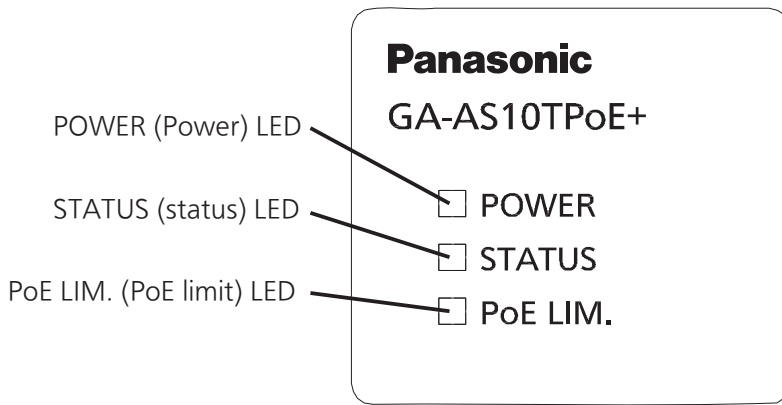

● **POWER (Power) LED**

Green Light : Power is ON.  
Off : Power is OFF.

● **STATUS (status) LED**

Green Light : System is normally operating  
Green Blink : After powering on, and the system startup is completed, blinks for five minutes  
Orange Light : System is starting up  
Orange Blink : System is malfunctioning

● **PoE LIM. (PoE limit) LED**

Off : Supplies power in a range of 0 – 63 W  
Green Light : Supplies power in a range of 63 W – 70 W  
Green Blink : When the requested power supply capacity exceeds 70 W (overload of the device overall)

● **Port LED (Left)**

LINK/ACT (ports 1 - 12) LED  
Green Light : Link is established.  
Green Blink : Data is being sent/received.  
Off : No terminal is connected.

● **Port LED (Right)**

PoE (ports 1 - 10) LED  
Green Light : Power is supplied normally.  
Green Blink : Overload power supply  
Off : Power is not supplied or PoE receiving equipment is not connected.

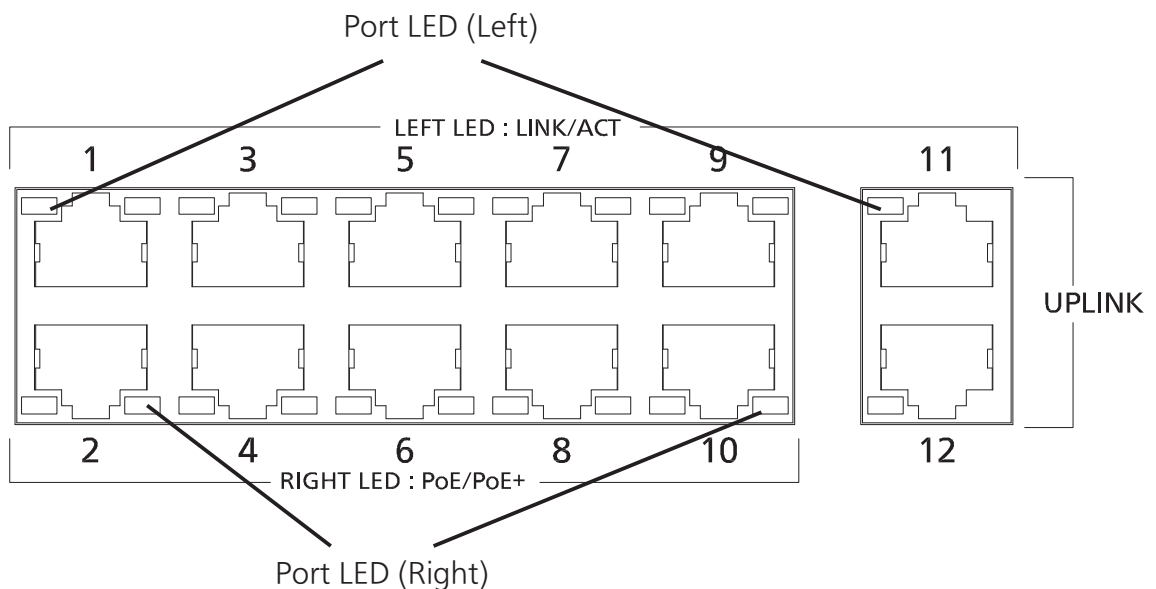

## 3 Installation and Configuration

### 3.1 Grounding Cable Connection

The chassis of the equipment must be grounded properly so that the lightning can flow to the ground, which improves the capability of the chassis for resisting the electromagnetic interference.

1. Ensure that the grounding cable is connected correctly so that the equipment is protected against lightning and interference. The correct connection of the grounding cable is an important measure to ensure the human safety.
2. Connect the chassis to the ground by using a grounding cable. The grounding resistance must be smaller than 0.10 ohms and the gauge of the grounding cable must be no less than 18 AWG and the length is 50 cm.
3. The ground installed screw shall comply with 3.5mm minimum in nominal thread diameter, and engage at least two complete threads into metal chassis with appropriate fixing hardware like washer.
4. The grounding cable shall not be removed during normal operation, servicing or maintenance.
5. Installation steps:  
Step 1: Ensure the detachable power supply cord is removed.  
Step 2: Use the screwdriver to turn the screws on the earth ground screw point.  
Step 3: Strip one end of the ground wire to the ground hole of system.  
Step 4: Connect the other end of the ground wire to a suitable grounding point of building at your side.  
Figure shows the grounding points.

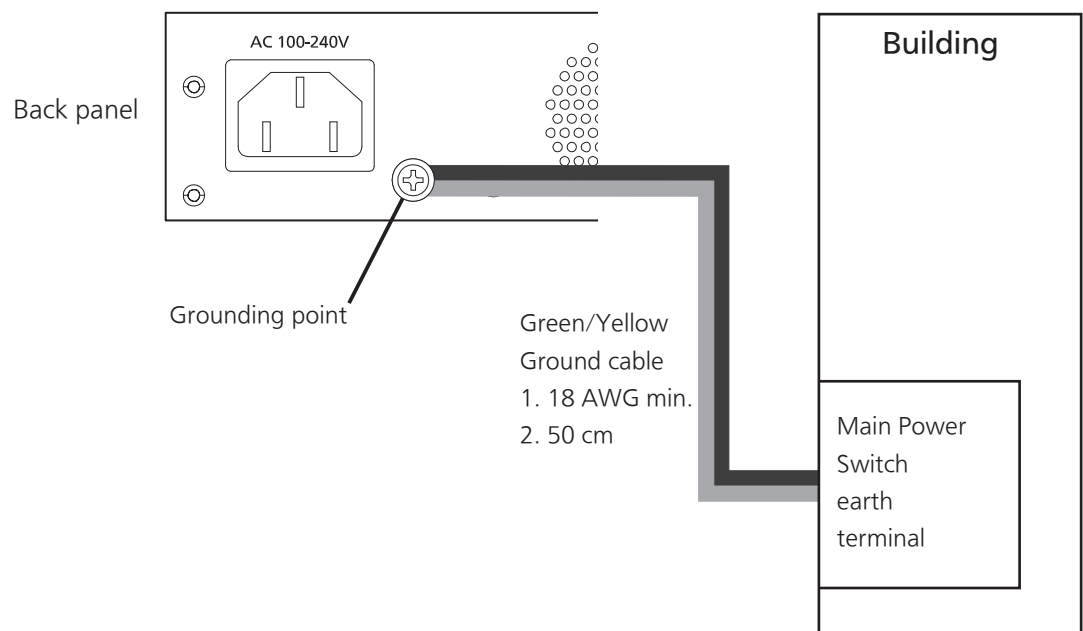

## 3.2 Mounting to rack (PN25108-NZ only)

Use the two 19-inch rack mount brackets and eight screws (for fixing the rack mount brackets to the Ethernet Switch) supplied with the mount brackets to fix the mount brackets to the four holes on each side of the Ethernet Switch.

Then securely install the Ethernet Switch onto the rack using the four screws (for a 19-inch rack mount) supplied with the mount brackets or the screws supplied with the rack.

Up to two Ethernet Switches can be connected. When connecting two Ethernet Switches and installing them onto a rack, use the two 19-inch rack mount brackets and eight screws (for fixing the rack mount brackets to the Ethernet Switch) supplied with the mount brackets to fix the mount brackets to the four holes on one side of the Ethernet Switches.

Then use the two connection brackets and eight screws (for fixing the connection brackets) supplied with the mount brackets to securely fix the connection brackets to the connection screw holes on the front and back panels, and then install the Ethernet Switches onto the rack.

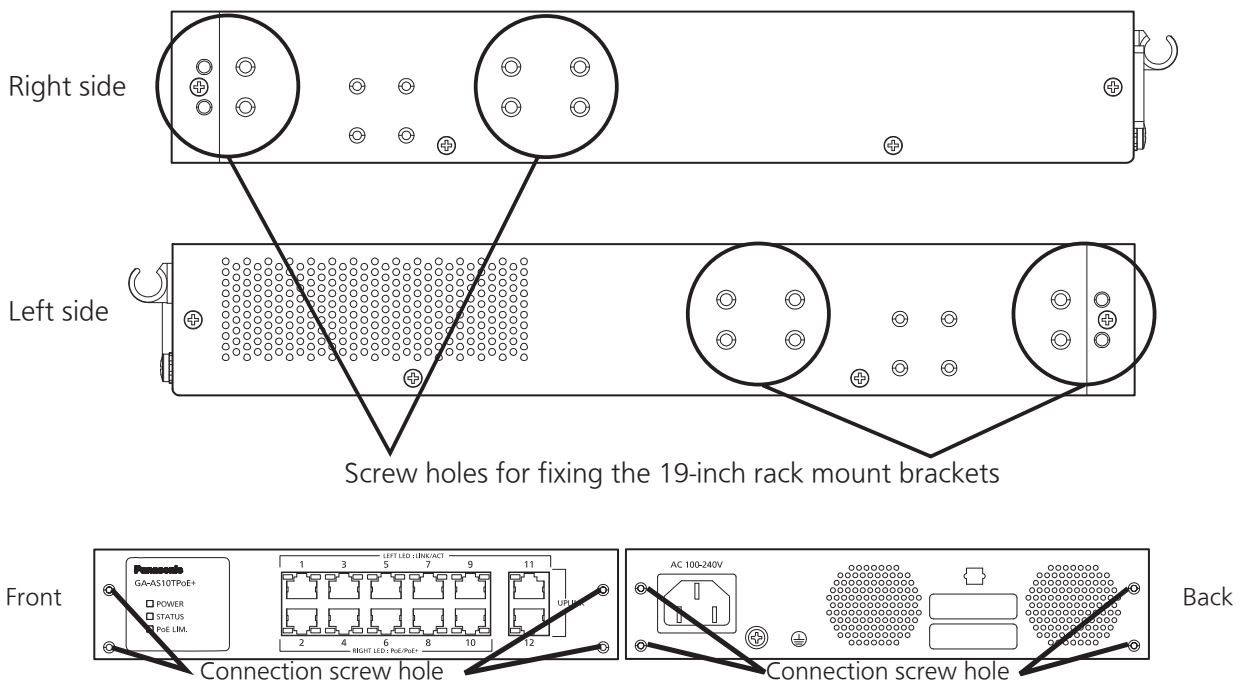

- Installation on a rack (one unit)

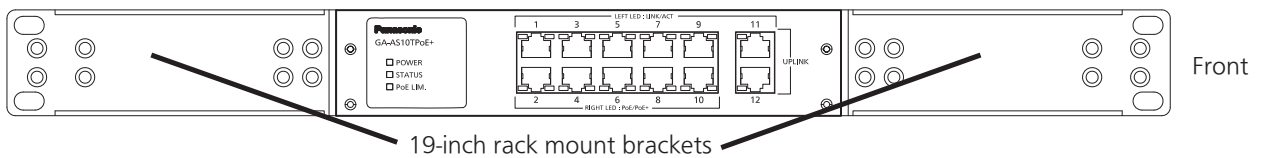

- Installation on a rack (two units connected)

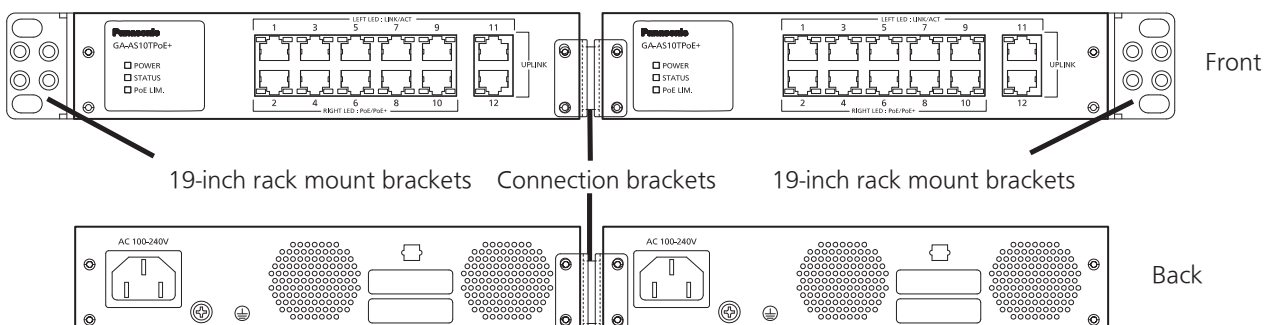

## 3 Installation and Configuration

### 3.3 Configuration of IP address (Basic)

- (1) Directly connect the computer which has ZEQUO assist Plus installed on it and this device via twisted pair cables, or connect the computer and this device to the TCP/IP network in the broadcast domain which the L3 switch routers do not go through, and start up ZEQUO assist Plus.
- (2) From the list on the left side of the screen, click the "IP Address Easy Setup" button to display the screen shown in Screen 1.
- (3) Press the "Search" button. This application starts searching for Ethernet Switches within the broadcast domain. In a few seconds, the screen displays the list of detected Ethernet Switches. (Screen 2)
- (4) From the list of the detected Ethernet Switches, select a device that you want to configure. In the "Setting item" field in the lower part of the screen, configure "Network setting", "Switch name", and other items.
- (5) Fill in the setting items and press the "Setting execution" button to display the confirmation screen shown in Screen 3. Press "Yes" to configure the settings and "No" to cancel them.
- (6) After the settings are reflected into the device correctly, the message shown in Screen 4 appears indicating the completion of the settings. If an error message appears, you should search for them again or check the network.

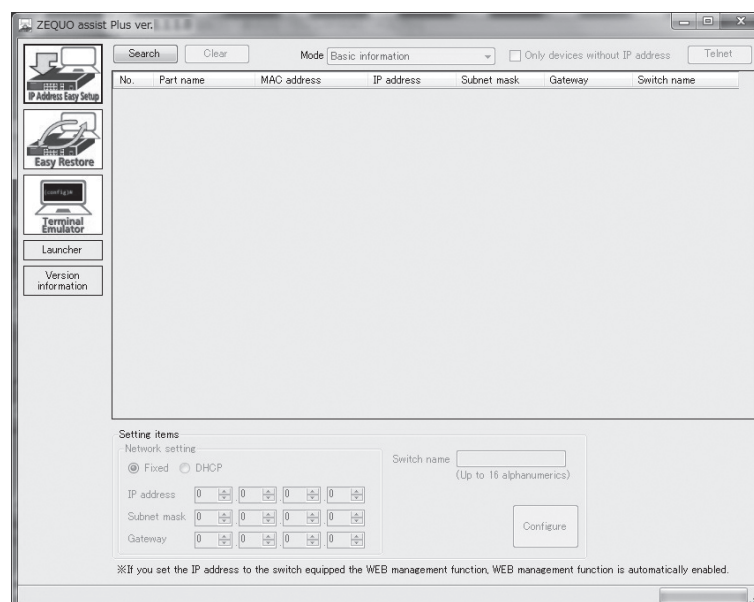

Screen 1

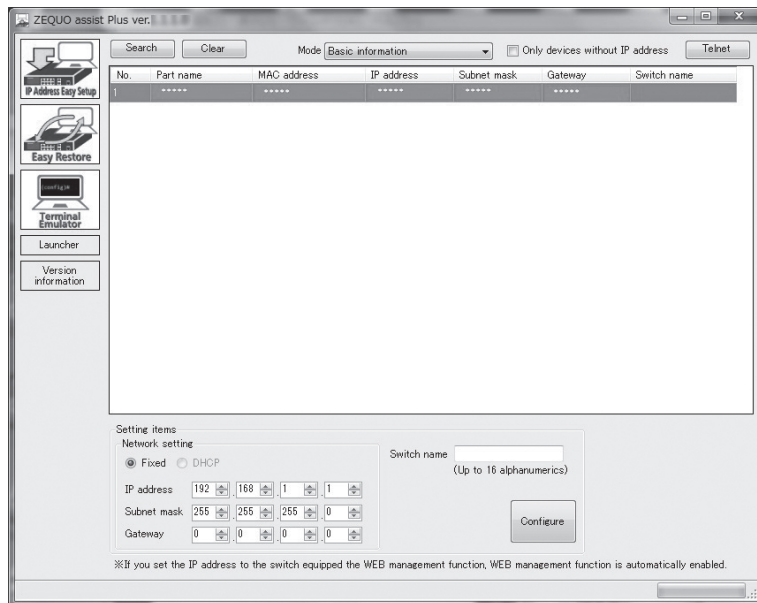

Screen 2

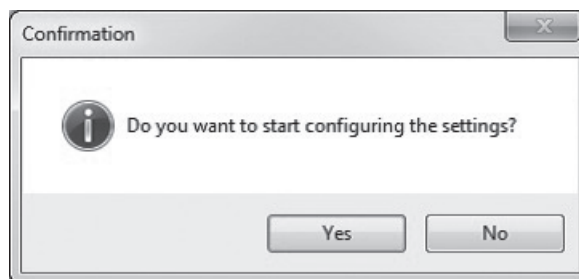

Screen 3

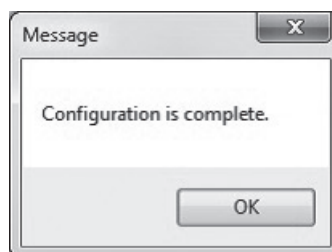

Screen 4

\* For detailed settings and administration methods, please see the PDF version of the Operating Instructions on Panasonic's website.

# Troubleshooting

If you find any problem, please take the following steps to check.

## ◆ LED

The **POWER (Power) LED is not lit.**

- Check if the power cord is connected. Please confirm that the power cord is securely connected to the power port.
- Is the Ethernet Switch used at a temperature between 0 and 50°C?  
Use the Ethernet Switch in its operating temperature range.

The **Port LED is not lit.**

- Is the cable correctly connected to the target port?
- Is the cable appropriate to use?
- Are the terminals which are connected to the appropriate ports, 10BASE-T, 100BASE-TX or 1000BASE-T compatible?
- Auto-negotiation may be failing.  
Set this device's port setting or the terminal's setting to half-duplex.

## ◆ Communications are slow.

- Are the communication speed and mode settings correct?  
If the proper communication mode signal cannot be obtained, apply half-duplex mode.  
Please reconfirm Auto-negotiation setting.
- Is the utilization ratio of the network to which this Ethernet Switch is connected, not too high?  
Try separating this Ethernet Switch from the network.

## ◆ Communications fail.

- Is the link-up correct?  
Depending upon the devices connected, linking may not occur if the Power Saving Mode setting and/or the EEE (IEEE802.3az, Energy Efficient Ethernet functions) setting is "Enabled" . Change the settings as per the following.
  1. Change the Power Saving Mode setting to "Half" or "Disabled".
  2. Change the EEE (IEEE802.3az) setting to "Disabled".

## ◆ PoE power supply is impossible.

Power is not supplied to a Powered Device.

- If you use an STP cable, PoE power supply may not be possible depending on the installation environment. In such cases, use a UTP cable.
- Is a CAT5e or better straight cable (RJ45-8/8) used?
- Is the cable connected to the port 1–10 that supports PoE power supply?
- Ensure that either the port alone or the entire equipment is not overloaded.
- Is the Powered Device connected to the port compliant with the IEEE802.3at standard or IEEE802.3af standard?

Port LIM. LED is blinking green:

- Ensure that the total power supply demand from PoE-powered devices does not exceed 70 W.

When the power supply is suddenly shut off:

- Confirm that a single port is not overloaded [Port LED (right) is not blinking Green], or that the power supply capacity for the device overall is not being exceeded (PoE LIM. LED is not blinking green).

**\* Please refer to the instruction manual on the ZEQUO assist Plus on Panasonic's website in regard to settings and management methods.**